

RoHS Compliant

Rev.	change details	effective date	updated by	date
A	Initial release	2020.12.19	FHY	20.12.19

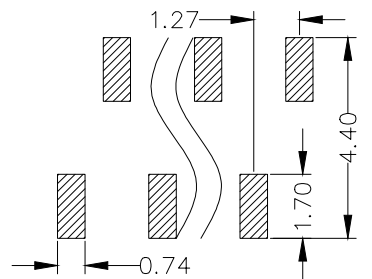
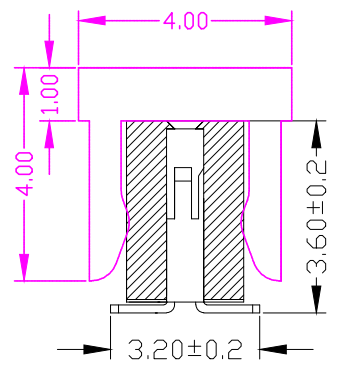
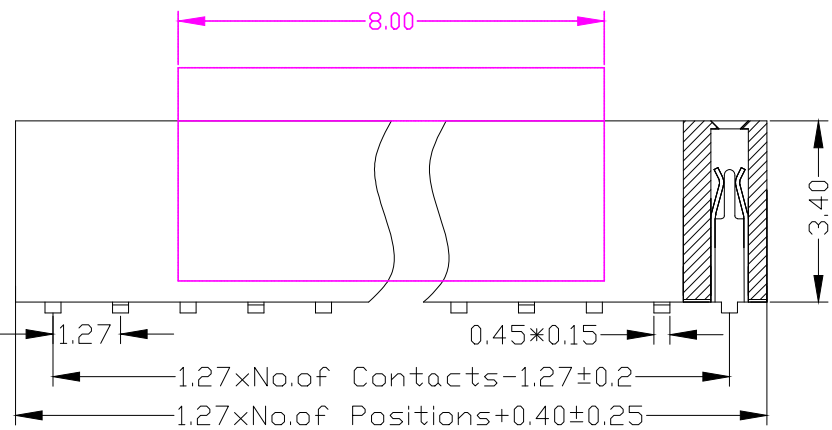
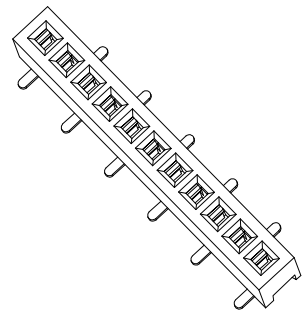
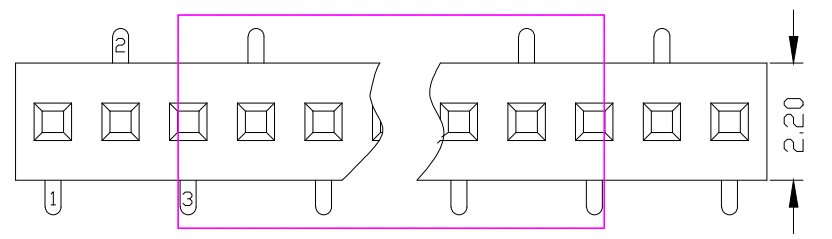

Recommended P.C.B. Layout

**Std. Material**  
 Contact: Phosphor bronze  
 Contact Plating: 1u" Au over 30u" Ni Min.  
 Insulator: PA6T(UL94V-0).  
 Insulator Colour: Black

**Temperature**  
 Operating Temp.: -40°C to 105°C  
 Max. Processing Temp.: 260°C for 10s

**Electronic Specifications**  
 Current Rating : 1 AMP  
 Contact Resistance : 20mΩ Max.  
 Insulation Resistance : 1000MΩ Min.  
 Withstanding Voltage : AC 500V for 60s  
**Packing** : Tape&Reel or agree on \_\_\_\_\_



**Ordering Information**

No. of Pins	Contact Plating	Insulator Material
Rows*Pins 2 x 50	SN: Tin <input type="checkbox"/> G0: 0.8u" Gold <input type="checkbox"/> G1: 1u" Gold <input type="checkbox"/> G2: 1.5u" Gold <input type="checkbox"/> G3: 2u" Gold <input type="checkbox"/> G4: 3u" Gold <input type="checkbox"/> G5: __u" Gold <input type="checkbox"/>	A: PBT <input type="checkbox"/> B: PA6T <input type="checkbox"/> C: PA9T <input type="checkbox"/> D: PA66 <input type="checkbox"/> E: PA46 <input type="checkbox"/> F: LCP <input type="checkbox"/> G: _____ <input type="checkbox"/>
Ordering:(N) 2X <input type="checkbox"/>		

**Ordering Dimensions**

A	B	C	D	H	W
PA	PB	PC	PD	PW	L

Remarks:

UNLESS OTHERWISE STATED DIMENSIONS IN mm TOLERANCE:	ORIGINALLY BY	 深圳市征华电子有限公司 Shenzhen ZWON Electronics Co.,Ltd.
	DRAWN: FHY	
	CHECKED: FY	
	APPROVED: FY	
DATE:2020.12.19	 发现更多 扫描官网	
ANGLEAR ±1°	LINEAR X 0.5 X.X ±0.2 X.XX ±0.1	

**Drawing No.** DRXXX-XX

Scale: FIT      Revision: A      Sheet: 1 of 1

**SERIES:** FH1.27/Single Row/SMT

TYPICAL: 1.27mm 单排母 塑高3.4

MODEL: SMT U型 正脚位

ZWON P/N:	Customer P/N:
-----------	---------------